

USER MANUAL

Revision 4, Jan 2002

IMPORTANT: Read these instructions before installing, operating, or servicing this system

OXFORD *Voyager*

Series 420, 550 and 800

**1.1.1 DO NOT DESTROY
KEEP KEY ENCLOSED AND MANUAL WITH
THE LIFT AT ALL TIMES.**

Instruction manual Part # 001.08860

INTRODUCTION

**This lift has been distributed by Joerns Healthcare Ltd.
It is manufactured by BHM Medical Inc, Quebec, Canada.**

Please take the time to read the entire manual, including the section on Safety Instructions and Warnings. It contains important information that will allow you to take advantage of all the characteristics of your Voyager patient lift.

Suitability

The Voyager range of lifts are suitable for the following categories of lift within the working parameters of the lifts specified in the technical specifications:-

Category A – Wheelchair
Category B – Bed
Category C – Bath
Category D – Toilet/ shower chair
Category E – Floor
Category F – 90 degree rotation

The Voyager series are suitable for patients in the sitting, sitting/recumbent and recumbent positions.

Approvals

CSA 601.1
UL 2601.1
EN 60601.1
EN ISO 10535 (Lifting device) SGS
UK Test Report: DUR22107/AC/OO

Note: BHM Medical is constantly improving its products. For this reason, it may be possible to encounter a modification of product without revision of this guide.



Joerns Healthcare Ltd
High St, Wollaston
Stourbridge
W.Midlands
DY8 4PS
Tel +44 1384 446688
Fax +44 1384 446699
www.joerns.co.uk

BHM Medical Inc.
2001 Tanguay Street
Magog (Quebec)
Canada J1X 5Y5
Phone: +1 (819) 868-044
Fax +1(819) 868-2249
www.bhm-medical.com
email: bhm@bhm-medical.com

TABLE OF CONTENTS

INTRODUCTION.....	2
Suitability.....	2
Approvals.....	2
1 INTRODUCTION	5
1.1 How to use this Manual.....	5
1.2 Equipment Identification.....	5
1.3 Receipt of Equipment.....	5
1.4 Key to Symbols.....	5
2 SAFETY INSTRUCTIONS AND WARNINGS.....	6
2.1 GENERAL.....	6
2.2 LIFTING WITH THE VOYAGER.....	7
2.3 SLING USAGE.....	7
2.4 ELECTRICAL WARNING - SHOCK PREVENTION.....	7
2.5 ELECTRICAL WARNING - INSTALLATION AND GROUNDING.....	8
2.6 ELECTRICAL WARNING - SERVICE AND MAINTENANCE.....	8
2.7 FIRE AND EXPLOSION PREVENTION.....	8
2.8 PARTS AND ACCESSORIES.....	8
2.9 EQUIPMENT WARNING LABELS.....	8
3 DESCRIPTION VOYAGER 420	9
3.1 Lift Unit.....	9
3.2 Parts Description.....	9
3.3 What's included.....	9
3.4 Dimensions.....	9
4 DESCRIPTION VOYAGER 550	10
4.1 Lift Unit.....	10
4.2 Parts Description.....	10
4.3 What's included.....	10
4.4 Parts Description.....	10
4.5 Dimensions.....	10
5 DESCRIPTION VOYAGER 800	11
5.1 Lift Unit.....	11
5.2 Parts Description.....	11
.....	11
5.3 What's Included with the Voyager 800.....	11
5.4 Dimensions.....	11
6 Operation.....	12
6.1 How to use the Voyager 420, Voyager 550 and Voyager 800.....	12
6.2 Sling Usage.....	13
6.3 Emergency Stop (Red cord).....	13
6.4 Emergency Lowering Feature.....	13
6.5 Emergency Brake.....	14
6.6 Frame with mechanical clips.....	14
6.7 Battery Information.....	14
6.8 Charging the battery.....	14
6.9 Charger Specification:.....	15

7	MAINTENANCE	16
7.1	Daily Check List	16
7.2	Inspection and Cleaning.....	16
7.3	Strap Inspection	16
7.4	Handling and Storage.....	17
7.5	Battery Replacement.....	17
7.6	Charger Fuse Replacement.....	17
7.7	.Charger Fuse Replacement (for UK only)	18
7.8	Sling Inspection.....	18
7.9	Annual Inspection	18
7.10	UK Regulations.....	18
7.11	Maintenance Inspection Checklist.....	19
8	TROUBLESHOOTING	20
9	ACCESSORIES	22
10	LOG BOOK.....	23
11	WARRANTY	26

1 INTRODUCTION

1.1 How to use this Manual



DO NOT ATTEMPT TO USE THIS EQUIPMENT WITHOUT UNDERSTANDING THIS MANUAL.

To ensure safe operation, read the entire manual carefully, especially the section on “Safety Instructions and Warnings”, before installing, operating, or servicing this equipment.

If anything is not completely understood, please contact your supplier for more details. Failure to comply with warnings in this manual may result in injury.

Keep this manual with the lift and refer to it as required. Contents of this manual are subject to change without prior notice to users.

Throughout this manual, the following symbols may appear. Pay particular attention to the information provided under these headings. These special annotations are easily recognized as follows:



WARNING: this symbol is intended to alert the user to hazards or unsafe practices, which could result in serious bodily harm.



CAUTION: this symbol is intended to alert the user of the presence of important operating and maintenance instructions, which could prevent product damage or possible personal injury.



NOTE: this symbol offers helpful information concerning certain operating procedures.

Additional copies of this manual can be purchased by contacting your supplier. Include the User Manual product number and equipment identification numbers.

1.2 Equipment Identification

The unit's identification number (specification, model, serial number) appears on a silver nameplate attached to the back of base.

1.3 Receipt of Equipment

Upon receipt of the equipment, verify it against the packing list to ensure it is complete and inspect the equipment for possible damage due to shipping. If there is any damage, DO NOT USE the equipment and notify the carrier immediately to file a claim. Provide complete information concerning damage claims or shipping errors to your supplier. Include all equipment identification numbers and group part numbers (if any) as described above along with a full description of damaged parts.

1.4 Key to Symbols

The following symbols are used on lifter's attachment labels:

CE This symbol is required to be displayed on regulated products for sale in the European Market. It indicates that the product complies with applicable European Directives related to health, safety, environment and consumer protection.

SWL Safe Working Load represents the maximum load the lifter is rated for safe operation.

The following symbols are used on sling labels and related to washing instructions:

 Maximum washing temperature 71°C (140°F) permanent cycle.

 Do not use bleach.

 Do not dry clean.

 Tumble dry low temperature.

 Do not iron.

Please refer to individual sling labels for complete instructions regarding washing and drying.

2 SAFETY INSTRUCTIONS AND WARNINGS

IMPORTANT – READ AND UNDERSTAND THESE INSTRUCTIONS. DO NOT LOSE THEM. ALSO READ OPERATING/ INSTRUCTION CHAPTER OF THIS MANUAL BEFORE INSTALLING, OPERATING OR SERVICING THIS EQUIPMENT

2.1 GENERAL

- Ø **IMPORTANT – READ THESE INSTRUCTIONS CAREFULLY OR SERIOUS INJURY MAY RESULT.**
- Ø **KEEP THESE INSTRUCTIONS AND THE KEY PROVIDED WITH THE LIFT AT ALL TIMES.**
- Ø **READ OPERATION AND MAINTENANCE INSTRUCTIONS IN THIS MANUAL BEFORE INSTALLING, OPERATING, OR SERVICING THIS EQUIPMENT.**
- Ø **An authorized contractor or installer must install Voyager ceiling lifts.**
- Ø **USE all controls and safety features only according to the rules specified in this manual. Never attempt to force a control or button on the lift.**
- Ø **DO NOT store the charger in a shower, bath or other areas with high humidity.**
- Ø **DO NOT drop the patient lift or battery. Dropping the battery or lift may cause internal damage that is not easily seen. If lift is suspected to be damaged, take to an authorized technician for servicing.**
- Ø **IMPORTANT: Keep all components of the lift clean and dry, and have electrical and mechanical safety checkpoints done as instructed in the Maintenance section of this manual.**
- Ø **Replace any precautionary or instruction labels that cannot be easily read.**
- Ø **Avoid violent shock during transportation.**

2.2 LIFTING WITH THE VOYAGER

- Ø **YOUR LIFT** is for transferring patients only. Do not use the lift for any other purpose.
- Ø **ALWAYS** carry out the daily checklist before using the lift.
- Ø Voyager ceiling lifts are intended to be used for patients within the specified weight limit indicated for the lift. Do not attempt to lift more than the weight limit indicated.
- Ø Before attempting to transfer, the patient must be assessed by a qualified professional.
- Ø Voyager ceiling lifts must be used by a caregiver with proper training to work with the patient to be transferred.
- Ø **ONLY** trained and qualified caregivers should transfer a patient. **DO NOT** attempt to use the lift if you have not been properly trained to do so.
- Ø **ALWAYS** be prepared before attempting to transfer a patient.
- Ø **FOLLOW** lifting procedures outlined in this manual.

2.3 SLING USAGE

- Ø **ONLY** use Oxford/Hoyer slings that are designed to fit with the Voyager
- Ø **ALWAYS** refer to the Sling User Manual for instruction on fitting, care and maintenance
- Ø **DO NOT** use a sling that is not recommended for the lift.
- Ø **NEVER** use a damaged, torn or frayed sling.
- Ø **ALWAYS** place the sling around the patient according to the instructions enclosed.
- Ø Voyager ceiling lifts are specifically designed for Oxford Voyager ceiling rail systems, slings and accessories. Slings and accessories designed by any other manufacturer are prohibited and will void the Voyager warranty. Use only Oxford/Hoyer slings and accessories to maintain patient safety and product utility.
- Ø **DO NOT** use other manufacturer's slings.
- Ø **DO NOT** use Oxford/Hoyer slings on other manufacturer's hoists.

2.4 ELECTRICAL WARNING - SHOCK PREVENTION

- Ø **DO NOT** touch or use a lift with bare conductors or a damaged power cord. Electrically live equipment can electrocute a patient. If the lift or charger has any exposed or damaged wires contact your local dealer immediately.
- Ø **DO NOT** cut or remove the round grounding prong from any plug. All Voyager lifts are equipped with three-prong plugs to protect from shock hazard or electrocution. Any two-prong electrical outlet must be replaced with a properly grounded three-prong outlet according to the National Electrical Code and local codes. It is the responsibility of the customer to have the work done by a qualified electrician.
- Ø **DO NOT** splash or expose electric parts of the device to water or moisture.
- Ø **CHECK** nameplate for voltage and cycle requirements. These requirements differ by country. Do not attempt to use the lift in an area that has a different voltage and cycle requirement.
- Ø **DO NOT** attempt to expose, service or repair the lift, battery or charger. If any unit is malfunctioning, contact your local dealer.
- Ø **READ** the battery and charger instructions thoroughly before using or storing them.

2.5 ELECTRICAL WARNING - INSTALLATION AND GROUNDING

- Ø Electrical equipment must be installed and maintained in accordance with National Electrical Codes.
- Ø Check nameplate for voltage and cycle requirements.
- Ø In special locations i.e. bathrooms, showers or swimming pools a supplementary earth bond must be connected at the mains supply socket. Where the Voyager Lift is supplied by a short length of flex from an adjacent power point, the green yellow connection within the flex may be deemed to constitute supplementary bonding. In some regions Local Authorities may specify an additional supplementary earth to the track. This can be taken from any earth terminal on the charger end stop.
- Ø *Refer to a qualified electrician who knows the latest regulations in the installation of this equipment.*

2.6 ELECTRICAL WARNING - SERVICE AND MAINTENANCE

- Ø Disconnect power cord from the charger rail stopper or switch of transformer at power supply, and unplug the battery from the lift before inspecting, adjusting or servicing the equipment. Disconnect power to equipment if it is to be left unattended or out of service.

2.7 FIRE AND EXPLOSION PREVENTION

- Ø Batteries may explode, leak and cause personal injury if not disposed of properly.
 - Do not place or store the battery under direct sunlight or near a heat source
 - Do not dispose of in fire
 - Do not short the battery terminals
 - Do not incinerate
 - Flush with water if electrolyte (Acid) comes in contact with skin or eyes.
- Ø Batteries must be recycled, disposed of according to local law regulations. When returning batteries, insulate their terminals with adhesive tape, etc. Otherwise, the residual electricity in used batteries may cause fire or explosion.



2.8 PARTS AND ACCESSORIES

- Ø Always use VOYAGER replacement parts and accessories. Using other parts and accessories other than recommended by BHM/ JOERNS could affect security and efficiency of the entire system. OXFORD VOYAGER slings and patient lift accessories are specifically designed to be used in conjunction with BHM patient transfer aids. Sling and accessories designed by other manufactures are not to be used as a component of VOYAGER patient transfer systems.

2.9 EQUIPMENT WARNING LABELS

- Ø INSPECT all precautionary labels on the equipment. Order and replace all labels that cannot be easily read.

3 DESCRIPTION VOYAGER 420

3.1 Lift Unit

OPERATING FEATURES

- Lifting capacity: 190 kg (420 lbs.)
- Average weight: 12.7 kg (28 lbs.) battery incl.
- Electronic soft-start and soft-stop motor.
- Manual & electric emergency lowering device.
- Emergency brake (for mechanical failure)
- Emergency stopping device.
- Current limiter for circuit protection.
- Low battery disconnect system to protect batteries from being drained.
- Lifting speed: 4 cm/sec. (1.6 in./sec.).
- Horizontal displacement speed: 20 cm/sec
- Vertical & horizontal motor: 24 VDC, 1/12 HP
- Strap length up to 2.2 m.
- ISO 10535.

3.2 Parts Description

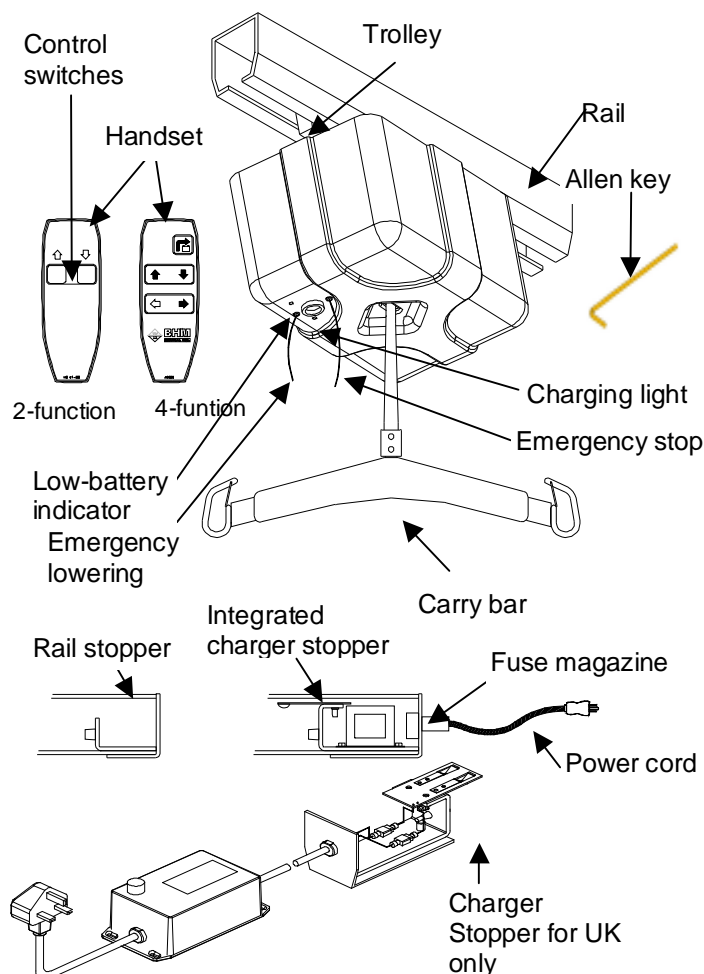

3.3 What's included

ITEM	QTY
Voyager 420 lift	1
Battery (inside unit)	1
Integrated Charger Stopper (hardwired for UK only)	1
Rail Stopper	1
Handset	1
Carry bar	1
Power cord	1
4mm Allen key	1
Instruction manual	1

3.4 Dimensions

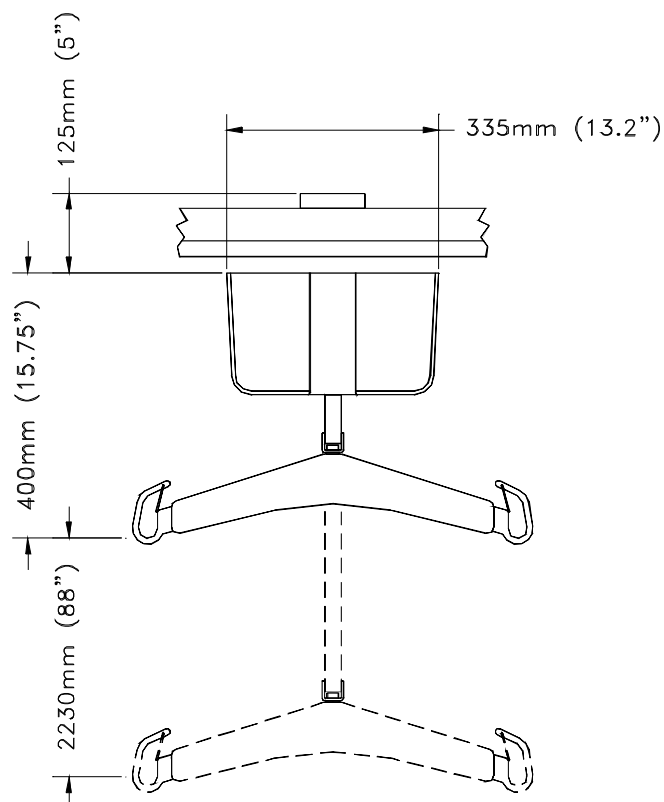

4 DESCRIPTION VOYAGER 550

4.1 Lift Unit

OPERATING FEATURES

- Lifting capacity: 250 kg (550 lbs.)
- Av. weight: 22.73kg (50 lbs.) battery included
- Electronic soft-start and soft-stop motor.
- Manual and electric emergency lowering.
- Emergency brake.
- Emergency stopping device.
- Current limit for circuit protection.
- Low battery disconnect system to protect batteries from being drained.
- Lifting speed: 6 cm/sec. (2.4 in./sec.)
- Horizontal displacement speed: 15 cm/sec. (6 in./sec.) and 25 cm/sec. (9.8 in./sec.)
- Vertical axis motor: 24 VDC, 1/8 HP.
- Horizontal axis motor: 24 VDC, 1/10 HP
- Strap length up 3.6 m (144 inches).

4.2 Parts Description

- As per Voyager 420 (previous page)

4.3 What's included

ITEM	QTY
Voyager 550 lift	1
Battery (inside unit)	1
Integrated Charger Stopper	1
Rail Stopper	1
Handset	1
Carry bar	1
Power cord	1
Instruction manual	1
4 mm Allen Key	1

4.4 Parts Description

- As per Voyager 420 (see previous page)

4.5 Dimensions

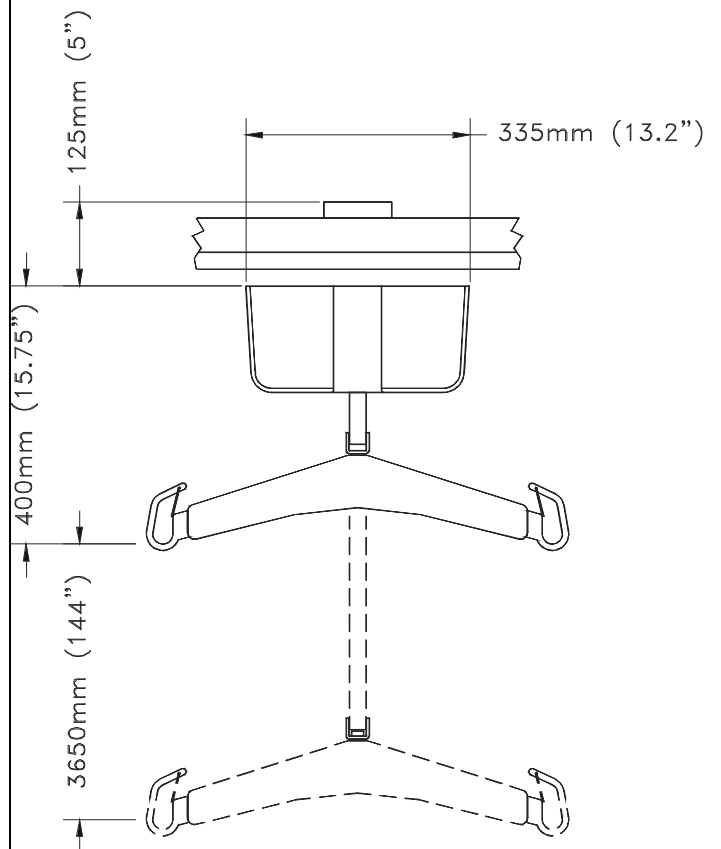

5 DESCRIPTION VOYAGER 800

5.1 Lift Unit

OPERATING FEATURES

- Weight capacity: 360 kg (800 lbs.)
- Average weight: 22.73 kg (50 lbs.) battery incl
- Electronic soft-start and soft-stop motor.
- Manual and electric emergency lowering.
- Emergency brake.
- Emergency stopping device.
- Current limit for circuit protection.
- Low battery disconnect system to protect batteries from being drained.
- Lifting speed: 3 cm/sec. (1.2 in./sec.)
- Horizontal displacement speed : 15 cm/sec
- Vertical axis motor: 24 VDC, 1/8 HP
- Horizontal axis motor: 24 VDC, 1/10HP.
- Strap length up to 1.3 m. (49.5 inches).

5.2 Parts Description

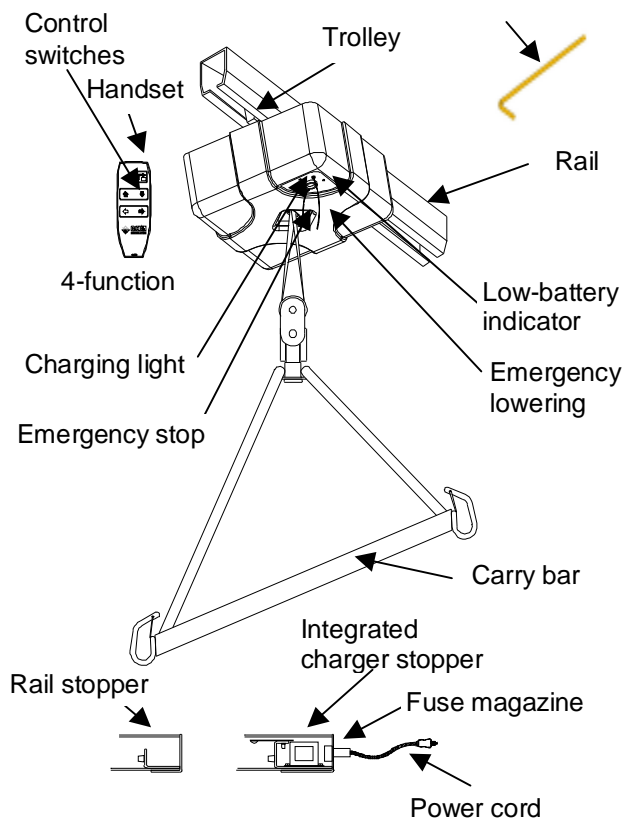

5.3 What's Included with the Voyager 800

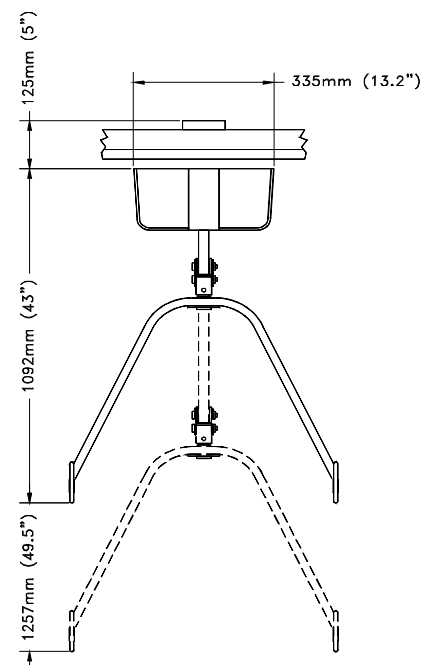

ITEM	QTY
Voyager 800 lift	1
Battery (inside unit)	1
Integrated Charger Stopper (Harwired version for UK market only)	1
Rail Stopper	1
Handset	1
Carry bar 450 kg (1000 lbs.)	1
Power cord	1
4 mm Allen key	1
Instruction manual	1

5.4 Dimensions



6 OPERATION

6.1 How to use the Voyager 420, Voyager 550 and Voyager 800

	READ "SAFETY INSTRUCTIONS AND WARNINGS" BEFORE ATTEMPTING TO USE THE VOYAGER. ONLY USE WITH OXFORD/HOYER SLINGS.
	Unit will not lift or lower when in contact with the charger.

1. Install the patient sling (see sling installation)
Move the lift directly over the patient.
2. For two-function unit pull the unit manually directly over the patient. For four-function, use the handset



	If the buttons do not operate on the handset, pull the red cord gently, once until you hear a "click"
---	---

Using the handset  button, lower the carry bar below the patient's chin (to avoid the risk of facial contact caused by a sudden movement of the carry bar) before beginning to attach the sling straps. If lift will not operate – pull red cord once gently, until you hear a click.

	Hold the lift carry bar with one hand at all times when near a person.
---	---

Note: In a lying down position, lower the carry bar near the thorax, then install the straps.

3. Attach the straps to the desired position (See separate Sling User Guide)
4. Carefully observe the patient to ensure his/her safety as you press the control button :





BEFORE LIFTING THE PATIENT:

1. Make sure that all straps are attached to the carry bar.
2. Make sure the patient is comfortable.
3. Make sure the sling is not caught on any obstruction (wheelchair brake or arm of chair).

If any of the above occur - Lower the patient immediately and correct the problem.

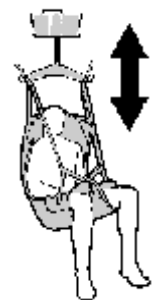
Lift until the patient's buttock clears the arm supports or the top of the bath or bed before moving the patient. Guide the legs past any obstacle.



5. When the patient is located above the desired point of transfer, press the  button.
6. Use the handles on the back of the sling to position the patient when transferring into a chair. Hold the handles firmly as the sling lowers and the sling will tilt back to position the person.
7. Once the patient is properly seated and the straps are loose, remove the sling from the lift.

	Hold the lift carry bar with one hand at all times when near a patient.
---	--

8. Slide the lift away from the patient.
9. When lift is no longer required:
 - 2-function - gently return the unit to charger manually.
 - 4-function engages the automatic return to charger function by pressing .
10. Check the charging indicator light to ensure the charger is working.

6.2 Sling Usage

- See separate Sling Manual for sling usage.
- Only use Sunrise (Oxford in UK) slings.
- Only use slings as per the manufacturer's guidelines.
- Inspect and maintain slings as per manufacturer's guidelines.

6.3 Emergency Stop (Red cord)

1. This can be activated at any time to stop the functioning of the lift.
2. To stop the lift in an emergency, pull the red cord once gently, you will hear a "click".

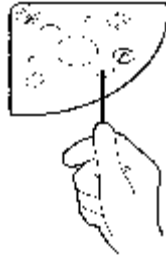

Do not pull red cord forcefully. If cord pulled too forcefully, lift may become inoperable.

3. When you initially receive your lift the emergency stop is in the "off" position. To activate the lift, pull the red cord once gently. To re-activate pull the red cord once gently, you will hear a "click".



6.4 Emergency Lowering Feature (White cord)

In the event of an electrical or functional failure, the Voyager 420, 550 and 800 have an emergency electrical and manual lowering feature

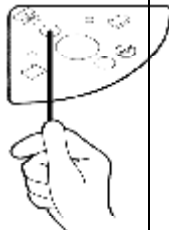

Only to be used in case of an emergency.

If the lift malfunctions when a patient is being transferred, the emergency lowering device provides a safe way of lowering the patient onto a chair or bed.

To operate the emergency lowering features:

Electrical Version:

1. Move the patient over a bed or a chair, and then gently pull down on the white cord. **If this does not function then go to step 2.**

Manual Version:

2. Find the rubber stopper and label on the side of the lift.

VOYAGER 420



VOYAGER 550 and 800

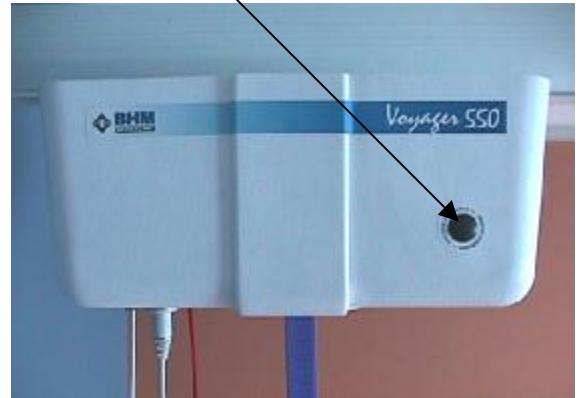

3. Pull the rubber stopper out of the Voyager casing – **DO NOT DISCARD**.
4. Use the Allen key provided with this manual, turn the key clockwise to lower the person into the chair. As the key turns the motor directly, each key turn will move the patient slightly.



OPERATION



To lower the patient more quickly, use a power drill with a 4mm Allen key bit.

- Once the patient is lowered safely into a chair or bed, call a certified technician to have lift serviced.

6.5 Emergency Brake

- The emergency brake is made of a metal bar fixed to the drum. 
- In case of a chain, gear or motor breakage, the centrifugal force created would block the bar against the frame.

6.6 Frame with mechanical clips

- Supporting structure is welded and reinforced with metal clips. 

6.7 Battery Information



DO NOT DROP THE LIFT. A DROPPED LIFT MAY HAVE INTERNAL DAMAGE THAT IS NOT VISIBLE. IT MAY LOSE ITS ABILITY TO RECHARGE.

Due to internal damage caused when the battery is dropped, the battery may indicate that it is fully charged, when in fact it cannot hold a full charge. A green light indicated on the lift may not accurately reflect a full charge on a damaged battery.

NEVER attempt to use a battery that appears to be damaged or dented.

DO NOT store the battery near a heat source. Heat will damage it.

- 24 Vdc, 7 Ah rechargeable battery.
- Provides up to 150 transfers with load of 75 kg (165 pounds).

Life cycle (number of charging cycles) of the battery is largely dependent on the depth of discharge in each cycle. The more the battery is drained, the shorter its life span. The life of the battery is also related to such factors as varying temperatures and rest periods between charge and discharge.

Graph 1: Number of recharges vs. Depth of discharge

Graph 1 illustrates the relationship between discharging depth and expected battery life.

If you drain the battery until it beeps every time, you can expect the battery to fully charge only 600 times.



To prolong battery life, return the lift to the charger **WHENEVER THE LIFT IS NOT IN USE.**

ery will not overcharge.

BHM uses sealed lead-acid batteries. Contrary to nickel-cadmium, BHM batteries do not have any memory effect. Therefore, batteries should not be completely drained before recharge.

Graph 2: Number of lifts vs. Lift load

The graph above (Graph 2) illustrates the relationship between the load lifted and the number of lifts that can be done with one recharged battery.



Do not drain the battery excessively. This will dramatically reduce the battery life span.

When battery buzzer sounds and red light flashes, be sure to recharge the battery as soon as possible.

6.8 Charging the battery



DO NOT operate the charger unit with a damaged cord or if the unit has been dropped or damaged.

DO NOT forcibly bend the power cord or place a heavy object on it. This will damage the cord and may cause fire or electrical shock.

DO NOT pour liquid on or near the charger.



Do not place the unit in locations that are:

- Extremely hot
- Dusty or dirty
- Very humid
- Moving or vibrating

The recharging steps should be as follows:

For the 4-function, press the  button to charge on the handset. Lift cannot return to charger with a 50-pound load.

For the 2-function, pull the lift gently over to the charger and ensure it is properly connected



DO NOT SLIDE THE LIFT TO CHARGER FORCEFULLY OR QUICKLY. CHARGER MAY BECOME DAMAGED.

- The indicator light will illuminate red to green depending on the battery drain. If the light does not go on, check “Troubleshooting” section in this manual for assistance.
- If the battery is low, the light will show red or orange when you return the lift to the charger. The light will gradually turn to green when fully charged.

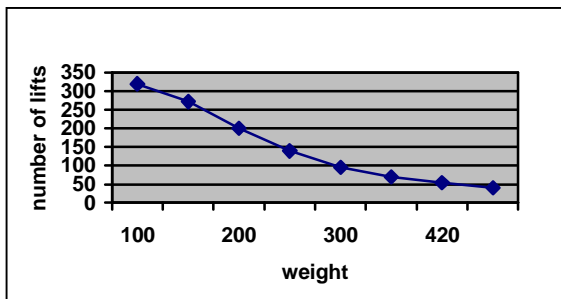



Whenever possible leave the lift on the charger when the lift is not in use. At minimum, charge the battery until the light is green before using it again. This will extend the life of the battery.

6.9 Charger Specification:

- Hospital grade charger cord and plug.
Charger input: 120 Vac, 60 Hz, 0.5 A. (North America) / 240 Vac, 50 Hz, 0.25 A (European)

7 MAINTENANCE



ALWAYS CARRY OUT THE DAILY CHECKLIST BEFORE EACH LIFT USE.

Alterations made to the VOYAGER 420, 550 or 800 by someone other than a certified technician may cause serious injury and voids warranty.

The VOYAGER 420, 550, 800 and accessories must be inspected **ANNUALLY** by a certified technician in addition to the daily and other periodic visual checks done by the user specified in this section.

Preventive maintenance specified in this manual can prevent accidents and reduce repair costs.

Note all service or repairs to the VOYAGER 420, 550, 800 or its accessories in the log book at the end of this manual. Have the document signed by the certified technician.

7.1 Daily Check List

THE FOLLOWING PROCEDURES MUST BE FOLLOWED BEFORE EACH USE.

- Has the battery been charged? Park the lift on the charger whenever the lift is not in use.
- Inspect the lift for any damage. If the lift casing does not look properly aligned, or there are any cracks or other damage on the lift, or any parts are missing - **DO NOT USE IT.** Contact your local representative to have the lift serviced.
- Inspect the visible strap for any signs of wear, frays, loose threads or other damage. If there is any evidence of damage - **DO NOT USE IT.** Contact your local representative to have the lift serviced.
- Inspect the sling for tears, frayed straps or loose stitching. If the sling has any of the above damage -**DO NOT USE IT.** Contact your local representative to have the sling replaced or repaired.
- Inspect the carry bar for any signs of cracking or damage.
- Ensure the ring and cotter pins that attach the carry bar to the strap are secure.

7.2 Inspection and Cleaning

Clean the Voyager with a soft dry cloth, or a soft cloth lightly moistened with a mild detergent solution. Do not use any type of solvent that may damage the finish.



Do not immerse lift in water.

To ensure a better rolling surface for the trolley wheels, clean the inside of the track every 4 months. To do so, insert a damp cloth in the opening and slide it from one end of the track to the other.

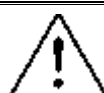

Always reinstall the rail end stopper (if they have been removed) after servicing.

7.3 Strap Inspection

This equipment is built with a strap that can withstand a load of 1364 kg (3000 lbs.) Nonetheless, if this strap is damaged or shows signs of wear, the acceptable load on the strap before rupture can drop rapidly and present a danger for the patient or caregiver.

BHM Medical recommends thoroughly inspecting the strap every 2 months as follows:

1. Completely unwind the strap.
2. Look for any signs of wear:



Loose threads in stitched area.

Noticeable discoloration by having a lighter color strap than the double thickness stitched area.

Side wear.

Middle wear.



If there is any signs of wear as indicated here or other visual defects, strap should be changed immediately. By continuing to use the lift without changing the strap, caregiver and patient safety is greatly compromised.

In any case, the manufacturer recommends changing the strap at least every two years. By continuing to use the lift without changing the strap, caregiver and patient safety is greatly

compromised.
 Take note of inspection results in the log book at the end of this manual.

7.4 Handling and Storage

Avoid violent shock during transportation.

The lift should not remain stored for long periods of time without recharging the batteries.



BHM Medical recommends charging of batteries at least every two weeks even if the lift is not used. This will prevent premature aging of batteries.

7.5 Battery Replacement

BHM uses sealed lead-acid batteries. Contrary to nickel-cadmium, BHM batteries do not have any memory effect. Therefore, batteries should not be completely discharged before recharge.

Replace the battery when there is a noticeable reduction in the number of transfers that can be performed between charges. If you notice the Voyager lift “beeping” and a red light flashing, see the instructions in “Troubleshooting” to ensure it is a problem with the battery.

To replace a battery, contact your local dealer or representative.



DO NOT ATTEMPT TO USE A BATTERY NOT AUTHORIZED BY BHM MEDICAL.

BHM batteries are specially designed for BHM charging systems. Attempting to use an unauthorized battery may seriously damage the lift and/or the charger.

7.6 Charger Fuse Replacement

If the light does not illuminate when there is a battery in it, do the following steps:

1. Check to make sure the power cord is correctly plugged into the charger in the wall.
2. Pull the power cord out of the charger. Under the socket for the power cord, there is a drawer or magazine where there are fuses. Using a pen or screwdriver, pull the drawer out gently. Pull the burned fuse out of the drawer that is next to the charger (see diagram below) and discard. Take the replacement fuse and place it in the same slot where the burned fuse was. Slide the drawer back into the charger. Plug the power cord into the charger. Place the lift onto the charger and check for the light.
3. Check the outlet to make sure it has power to it.
4. If the light does not illuminate, contact your local dealer or representative for assistance.

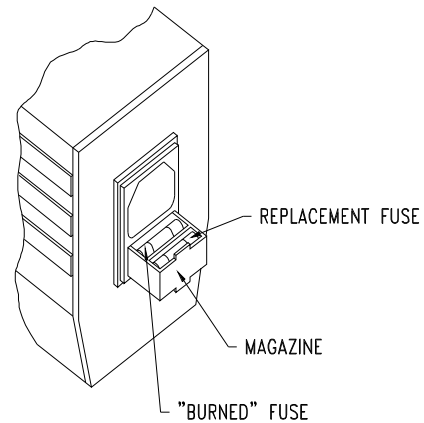

Replace the fuse with the following:

Fuse: GMC 0.5 A 250 V North America (when input is 120 Vac) Product # C8FGMC0.5

GMC 0.25 A 250 V European (when input is 240 Vac) Product # C8FGMC0.250

The fuse may also be ordered through your local dealer or representative.

7.7 .Charger Fuse Replacement (for UK only)

If the light does not illuminate when there is a battery in it, do the following steps:

1. Check to make sure the power cord is correctly plugged into the charger in the wall.
2. Disconnect the power cord from the wall.
3. Unscrew the fuse holder cap.

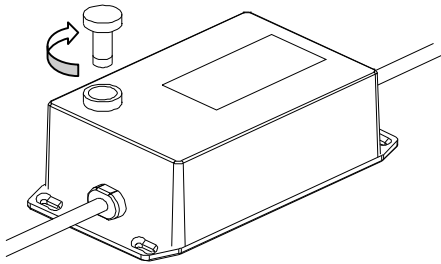

4. Replace the fuse with the following:
 - Fuse: CMC 0.5 A 250 V North America
 - Loose threads in stitched area
 - Noticeable discoloration by having a lighter color strap than the double thickness stitched area
 - Side wear (input is 240 Vac) Product # C8FGMC0.250
 - European
 - Middle wear
 - so be ordered through your local dealer or representative.
5. Screw back the fuse holder cap

 **Take note of inspection results in the log book at the end of this manual.**

7.8 Sling Inspection

- Refer to separate Sling User Guide
- Confirm the sling is an Oxford/Hoyer sling.
- Check the load bearing straps for wear or fraying
- Check the sling straps are securely stitched
- Check the body of the sling for wear, cuts in the fabric.
- Check any sling accessories (ie additional spreader bars / side suspenders) for wear on the hooks or central suspension point.

7.9 Annual Inspection

The Voyager 420, 550, 800 and its accessories must be inspected annually by a certified technician.

 **VOYAGER 420, 550, 800 AND ACCESSORIES MUST BE SERVICED EVERY 12 MONTHS AS A MINIMUM REQUIREMENT.**

Do not attempt to do the inspection unless you are certified to do so.

As part of the annual inspection, an annual load test with the safe working load must be performed on the VOYAGER 420, 550, 800 as required for CE MARK MAINTENANCE.

After annual inspection, have the log book signed by the certified technician.

7.10 UK Regulations

IN THE UK THE VOYAGER 420/550/800 MUST BE INSPECTED AND MAINTAINED IN COMPLIANCE WITH 1998 NO 2307 HEALTH & SAFETY: LIFTING OPERATIONS AND LIFTING EQUIPMENT REGULATIONS 1998. YOUR DEALER WILL PROVIDE YOU WITH MORE INFORMATION

MAINTENANCE INSPECTION CHECKLIST

7.11 Maintenance Inspection Checklist

TO BE INSPECTED BY USER						
ITEM	INITIALLY	BEFORE EVERY USE	EVERY 2 MONTHS	EVERY 4 MONTHS	EVERY YEAR	EVERY 2 YEARS
LIFT DEVICE						
Inspect for missing hardware or broken panel.	X	X			X	
Inspect strap for wear.		X	X			
Battery recharge.		X				
Inspect carry bar on the strap of the lift for damage or cracks.					X	
Inspect wheels in rail for damage, rust or cracks. Replace if damaged.					X	
Overall inspection by authorized personnel					X	
SLING AND HARDWARE						
Check all sling attachments for sign of wear.		X				
Inspect sling material for wear or deterioration.		X				
Inspect sling straps for wear.		X				
Inspect for any defects or loose threads in the "stitched areas".		X				
Cleaning sling as indicated on the tag.	<i>When Necessary</i>					
Verify emergency stop cord.				X		
Verify emergency lowering.				X		

MAINTENANCE BY A CERTIFIED TECHNICIAN						
Replace strap.						X
Inspect the welding aspect on the frame to detect cracks.					X	
Inspect sprockets for wear.						
Inspect connecting joints for proper attachment.					X	
Verify that the emergency brake on the drum is turning freely.					X	
Verify emergency devices for good functioning					X	
Load test with the SWL (maximum working capacity).					X	



Maintenance inspection points are suggested by the manufacturer, however in certain cases, some inspections should be done on a more frequent basis. By continuing to use the lift without replacing the listed parts in this maintenance inspection checklist, caregiver and patient safety is greatly compromised.

8 TROUBLESHOOTING



DO NOT attempt to open the VOYAGER SERIES LIFT. Only a certified technician is authorized to open the VOYAGER SERIES LIFT. Alterations made to the VOYAGER 420, 550 or 800 by someone other than a certified technician may cause serious injury.

PROBLEMS	TO CHECK
The unit starts and stops repetitively.	<ul style="list-style-type: none"> • If the load is over the safe working load, the unit will not work due to an overload protection on the motor. • Has the lift been making a “beeping” sound? The battery is low and needs to be charged.
The lift emits a "beep" and a red light flashes during utilisation. The unit may stop lifting but you can still lower it.	<ul style="list-style-type: none"> • Batteries are low, return to charger.
Charge indicator on the lift (green-red) does not light up when the lift is on the charger.	<ul style="list-style-type: none"> • Is the charger stopper plugged into a standard outlet? If so does the outlet have power? • Check the condition of the fuse. If needed, change it with a spare one. (see “Maintenance” section of this manual)
Battery is always dead after a few transfers (3 to 5).	<ul style="list-style-type: none"> • Replace battery with a new one, the life of the current one is probably nearly over. (Contact your local dealer or representative to have battery replaced)
The light on the charger shows green yet the lift will only do one or two transfers.	<ul style="list-style-type: none"> • Contact your local dealer or representative to have battery replaced.
The light on the charger shows green yet the lift will only work when there is no one in the lift. When you attempt to transfer someone, the lift stops.	<ul style="list-style-type: none"> • Contact your local dealer or representative to have battery replaced.
The lift does not work when you press the buttons on the handset.	<ul style="list-style-type: none"> • Is the charger light on? Lift must be moved away from the charger in order to operate. • Is the emergency stop activated? Gently pull the red cord once until you hear a ‘click’. Try the buttons again. • Is the handset properly plugged into the lift? The handset may be slightly pulled out of its socket yet appear as though it is plugged in. The lip of the handset must be flush with the cab of the lift. The socket and handset connector is a tight fit – press firmly to ensure the handset is plugged in properly. • If the handset was not properly plugged into the lift, it may be necessary to gently pull the red cord once again. • Slide the lift over to the charger. Is the light red or not on at all? Battery likely needs to be charged. See troubleshooting situations above for more information. • If, after testing all of the above, the lift will not operate, contact your local dealer or representative.
The charging light on the lift remains red and does not turn to green after an overnight charge.	<ul style="list-style-type: none"> • If available, try another integrated charger stopper from another lift or a spare one; plug it into the rail and charge for 3 hours. If the light does not change to white or green, contact your local dealer or representative. • Using a voltage meter, test the two contact points on the charger (see diagram T-1). The voltage meter should read between 26-30 volts AC.

TROUBLESHOOTING

PROBLEMS	TO CHECK
When you press the button to return the lift to its charger (4-way motors only), the lift goes to the charger but does not lower the carry bar and you can hear a 'humming' sound.	<ul style="list-style-type: none"> • Contact your local dealer or representative. • Charger either does not have power or is not working properly, see troubleshooting question above.

DIAGRAM T-1

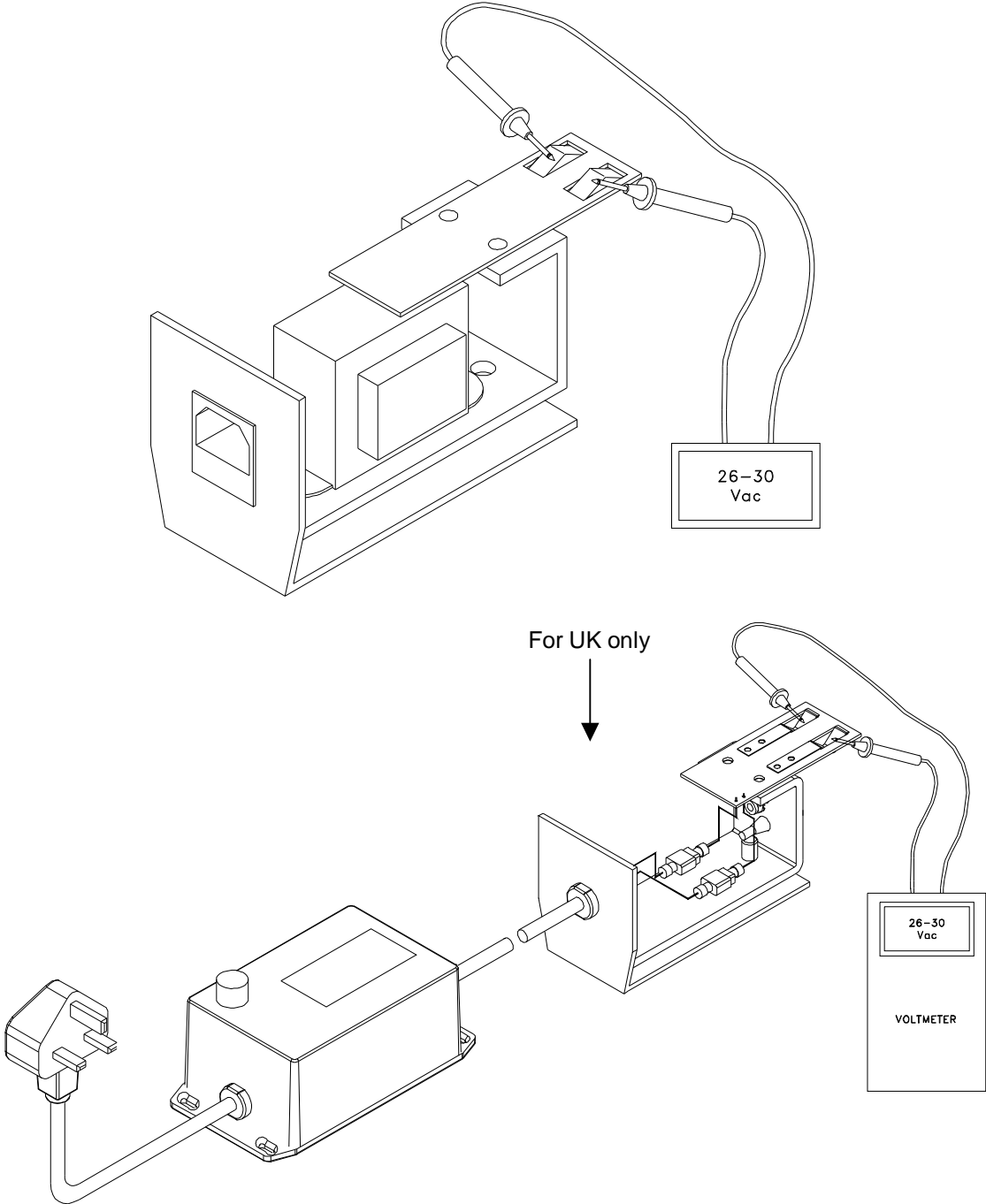

9 ACCESSORIES

INTEGRATED CHARGER STOPPER

Product No. A5300

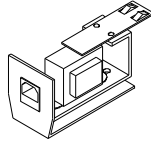

RAIL STOPPER

Product No. A5320



ERGOSCALE WEIGHING DEVICE

Product No. ERGOSCALE-T2

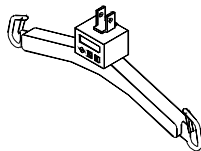

INFRARED REMOTE CONTROL

Product No. A5400

(must be ordered with lift)

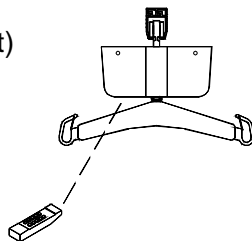

TIMER FOR RETURN TO CHARGE

Product No. A5200



TRAPEZE BAR

Product No. A5700

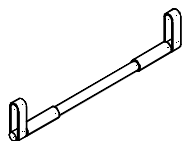

FUSE

Product No.

C8FGMC0.25 (240/24 volt) European

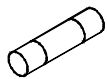

SEMI PERMANENT RACK

Product No. A9200

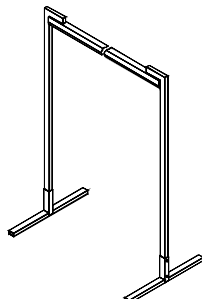

HANDSET

2-button - Product No. E0093

For VOYAGER 420 and 550

2 functions

6-button - Product No. A0086

For VOYAGER 420 and 800

4 functions

8-button - Product No. A5600

For VOYAGER 550

4 functions

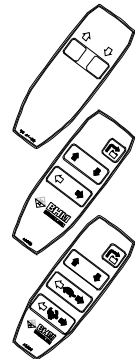

LOG BOOK

Service Type <input type="checkbox"/> Pre-delivery <input type="checkbox"/> Periodic inspection <input type="checkbox"/> Minor <input type="checkbox"/> Major	
Condition report : _____ _____	
Action taken : _____ _____	
Date : _____	Inspected by: _____ Printed Signature

Service Type <input type="checkbox"/> Pre-delivery <input type="checkbox"/> Periodic inspection <input type="checkbox"/> Minor <input type="checkbox"/> Major	
Condition report : _____ _____	
Action taken : _____ _____	
Date : _____	Inspected by: _____ Printed Signature

Service Type <input type="checkbox"/> Pre-delivery <input type="checkbox"/> Periodic inspection <input type="checkbox"/> Minor <input type="checkbox"/> Major	
Condition report : _____ _____	
Action taken : _____ _____	
Date : _____	Inspected by: _____ Printed Signature

Service Type <input type="checkbox"/> Pre-delivery <input type="checkbox"/> Periodic inspection <input type="checkbox"/> Minor <input type="checkbox"/> Major	
Condition report : _____ _____	
Action taken : _____ _____	
Date : _____	Inspected by: _____ Printed Signature

11 WARRANTY

This warranty is extended only to the original purchaser/user of BHM products.

BHM Medical Inc. warrants its products to be free from defects in material under normal use and service, within the periods stated below from the date of purchase. If within such warranty period any such product shall be proven to be defective, such product shall be repaired or replaced at BHM Medical's option. This warranty does not include any labor or shipping charges incurred in replacement part installation or repair of any such product. BHM Medical's sole obligation and your exclusive remedy under this warranty shall be limited to such repair and/or replacement.

Patient Lifter	1 year
Weighing Devices	1 year
Accessories on Lifter	1 year
Slings	1 year
Batteries - Voyager Portable	3 months
Batteries - All other lifts	1 year
Easytrack System	1 year

For warranty service, please contact the dealer from whom you purchased the BHM Medical product. [In the event that you do not receive satisfactory warranty service, please contact BHM Medical (see contact information in Table of Contents).]

Do not return products to our factory without prior authorization. BHM Medical will issue a Return Merchandise Authorization (RMA) Number. C.O.D. shipments will be refused; all shipments to BHM Medical must be prepaid. For this warranty to be valid, the purchaser must present its original proof of purchase at the moment of the claim. The defective unit, assembly or part must be returned to BHM Medical for inspection. The part or components repaired or replaced are guaranteed for the remaining period of the initial warranty.

Limitations and Exclusions:

The warranty above does not apply to serial numbered products if the serial number has been removed or defaced.

No warranty claim shall apply where the product or any other part thereof has been altered, varied, modified, or damaged; either accidentally or through improper or negligent use and storage. Warranty does not apply to products modified without BHM Medical's express written consent, (including but not limited to products modified with unauthorized parts or attachments); products damaged by reason of repairs made to any component without the specific consent of BHM Medical, or to products damaged by circumstances beyond BHM Medical's control. BHM Medical will solely determine evaluation of warranty claim. The warranty does not apply to problems arising from normal wear or failure to adhere to the instructions in this manual. BHM Medical Inc. slings are void of warranty if not laundered as per instructions on the Sling Label.

BHM Medical Inc. nor Joerns Healthcare Ltd shall not be liable for damages losses or inconveniences caused by a carrier.

This warranty replaces any other warranty expressed or implicit and constitutes BHM Medical Inc. only obligation towards the purchaser. BHM Medical shall not be liable for any consequential or incidental damages whatsoever.